

Building the Home of Your Dreams

Illinois Touchstone Energy Home



Brought to you by



Association of Illinois
Electric Cooperatives

A Touchstone Energy® Member 

 **JCE CO-OP**

Your Touchstone Energy® Cooperative 



Lower your cost of living.

We never seem to forget that the cost of owning a car includes the cost of gasoline. But for some reason many of us forget that the cost of owning a home includes more than a mortgage, insurance and taxes – it also includes the energy bills. You might ask what local or state tax credits and incentive programs are available for home energy efficiency. Talk to your lender about the advantages of energy efficient mortgages. Your local electric co-op’s energy experts and this manual can help you build a home that gets more “miles to the gallon.”



If you don't remember anything else... remember this.

- Though some of the items presented in this booklet seem insignificant, it is the use of the total concept that provides for measurable energy savings.
- The construction of corner posts and partition junctures should minimize air pockets and allow for full depth of insulation.
- It is recommended that cellulose or foam insulation be used in ceilings and walls. We DO NOT recommend using fiberglass insulation in these locations.
- When insulating the basement or crawl space, do not forget to insulate the box sill.
- Caulking and sealing of the exterior walls and components is a vital part of the overall efficiency of a home.
- The attic area should be insulated to a minimum R-49. We highly recommend using blown cellulose in attics.
- Basements and associated, loose-fitting windows have more heat loss than most people realize.
- Geothermal heat pumps are the most efficient heating/cooling systems available today. They move heat energy rather than create it and are four to six times more efficient than a gas furnace.
- Because windows and glass doors are major areas of heat loss and gain, they should be sized so they are no more than 10 percent of the floor area.
- Heating and cooling ductwork should be within the conditioned space of the home, but when this isn't practical or possible, ducts should be air-sealed and insulated to IECC specifications.

Illinois Touchstone Energy Home

Building the home of your dreams

Making an energy efficiency investment in your new home today will mean you'll have a comfortable, quiet and economical home for life. This Illinois Touchstone Energy Home manual can help you achieve these goals.

Table of Contents

Introduction	4
Controlling Comfort	5
Moisture Control	5-6
Recommended Construction, Air Sealing & Insulating Standards	
Caulking and Sealing	6
Walls	7
Basement Walls	8-9
Structural Insulated Panels	9
Insulated Concrete Forms	10
Steel Framing	10
Ceilings and Attics	11-12
Floors	13
Floors over Crawl Space	13
Concrete Slab Floors	13
Windows and Doors	14-15
Heating, Ventilation and Air-Conditioning Systems (HVAC)	16-17
Domestic Hot Water (DHW)	18
Lighting	18
Energy Certificate	19
Conclusion	19
Summary of Recommended Construction Standards	20



Published by the Association of Illinois Electric Cooperatives

NOTE: This manual is provided for informational purposes only. The Association of Illinois Electric Cooperatives has no control over the conditions under which this information may be used; therefore, the AIEC makes no warranty, expressed or implied, with respect to the accuracy, completeness, or usefulness of the information, nor assumes any liabilities with respect to the use of any information, apparatus, product or process disclosed in this manual.

Revised 2020

Introduction

Illinois Electric Cooperatives are pleased to provide the Illinois Touchstone Energy Home guide to Building the Home of your Dreams. This booklet provides lots of great ideas on how to build an energy efficient home that will provide you and your family with a comfortable, affordable and efficient home for many years.

If you are planning to build a new house in the future, we advise building to the standards in this booklet. In addition, the concepts and ideas referenced in this booklet generally apply to renovation and remodeling projects.

This booklet meets the requirements of the current International Energy Conservation Code (IECC), which has been adopted in the State of Illinois. Illinois electric cooperatives recommend that any new home meet the current IECC standards, which are state law.

A committee consisting of Brad Austin, Egyptian Electric Cooperative Association; Drew Haumesser, Coles-Moultrie Electric Cooperative; Jeremy Myers, Corn Belt Energy Corporation; John Scott, Jo-Carroll Energy, Inc.; and Nancy McDonald, Association of Illinois Electric Cooperatives, is primarily responsible for this effort. Also assisting was Darren Meyers, P.E. of International Energy Conservation Consultants, LLC. As an expert on energy efficiency and the IECC, the cooperatives called upon Meyers to ensure that the recommendations in this new publication met the code requirements.

Many thanks to the committee and Meyers for their work.

If in doubt about anything in this booklet, or have questions involving new home construction, please remember to ALWAYS contact the energy efficiency professionals at your electric cooperative. We'll be glad to help you successfully build the ENERGY EFFICIENT "Home of Your Dreams."



Conventional Construction Methods

\$ Energy Dollar



60¢

Heating & Cooling



15¢

Water Heating



25¢

Other

=

0¢
Savings

Illinois Touchstone Energy Home Construction Standards

\$ Energy Dollar



25¢

Heating & Cooling



5¢

Water Heating



25¢

Other

=

45¢
Savings

Controlling Comfort



Radiation



Conduction



Convection



A home loses heat in three ways, as shown in **Fig. 2**, **Fig. 3** and **Fig. 4**. One source of heat loss is through **RADIATION**. Just as you feel heat “radiating” from a fireplace, your home radiates heat to the outside in the winter and is on the receiving end of heat radiated by our sun to the inside in the summer. There have been attempts to minimize the amount of heat lost or gained through radiation by wrapping homes with foil-like materials that reflect radiation back into the house or away from the home, to the outside environment, depending on the season. In Midwest climates, these foil-like materials are generally less cost-effective than in southern states where solar gains are higher.

However, radiation is also the idea behind low thermal emissivity (low e) glass in energy efficient windows. Using low e glass in windows, along with light-colored roofing and siding materials, and locating windows so that they are not directly impacted by the sun’s radiation in the summer, are all economical ways to reduce the impacts of summer radiation and help lower cooling costs.

The second way heat is gained and lost is through

CONDUCTION. Remember that heat always flows from a warm surface to a cooler surface. If the interior environment of your home is warmer than the exterior, heat will flow from the interior to the exterior through direct contact with walls, windows, doors, floors and roof/ceiling components. The amount of heat that flows through these building surfaces is dependent on the temperature difference between the environments separated by these surfaces and the rate of heat transfer through the materials involved. The greater this temperature difference, the greater the heat flow and the associated heat loss or gain. This heat loss or gain can be slowed by lowering the rate of heat transfer through building components with good insulating values.

The third way that a home loses heat is through **CONVECTION**. This is simply the transfer of heat through the movement of air. This type of heat transfer can be associated with uncontrolled air leakage into or out of the home, but also through convection currents—warm air rising or cold air descending that can occur within wall, floor and window cavities.

Moisture Control

In Illinois, moisture-related problems in a home can occur in winter and summer. In winter, cold air only holds a small amount of water vapor, while warm air inside can hold a considerable amount from cooking, bathing and even the evaporation of standing water from fish tanks and plants. As this vapor level grows, it builds pressure indoors (at higher vapor pressure), forcing the vapor into the walls and toward the outside, colder air (at lower vapor pressure). When air is cooled, the relative humidity (RH) of the air (the amount of water vapor it can hold) increases. If the RH of the air reaches 70 percent or higher, mold growth can begin.

In summer, outdoor air that has a high RH, along with wind-driven rains, can penetrate cracks and openings in the building’s exterior cladding. As it is forced inward into the wall cavity by wind, vapor and heat, it can eventually reach interior, air-conditioned wall material. As the air carrying the water vapor is cooled (inside is air-conditioned in the summer), its RH will rise. Once again, if the RH reaches 70 percent or higher, mold can begin to grow.



Moisture problems can often lead to mold issues, as shown in this attic.

The best strategies to prevent water vapor/moisture issues are complicated. Improper insulating methods can contribute to problems. When insulating homes in Illinois, we do not recommend installing a vapor retarder (such as 6-mil polyethylene plastic, insulation faced with kraft paper or certain thicknesses of closed-cell, high-density foam insulation products). The result of this construction approach allows any moisture that does penetrate a wall cavity to eventually dry out. A latex

Moisture Control Cont.

or enamel paint primer coat on the inside surface of exterior walls and ceilings, caulking and air-sealing materials and proper insulation levels are sufficient. By air-sealing cracks, holes, spaces around pipes and conduit, and joints between materials in exterior walls, floors and ceilings, air transport of water vapor to cold surfaces is restricted.

To eliminate summer migration of high humidity air into the wall cavity, the exterior of the home must have a continuous air barrier. Many builders use house wrap as the air barrier. For house wrap to be truly functional as an air barrier, all seams and edges of the wrapping material must be sealed with tape or fasteners in accordance with the manufacturer's instructions. The house wrap should also continue upwards to cover gable ends of the home in such a fashion that wind-driven rain is not able to

drive into or behind the wrap.

There are many new products being developed to maintain a continuous air barrier on the exterior while ensuring the home is structurally sound and of weather-resistant construction in an economical fashion. One of these newer products is an exterior sheathing that has a special coating on its outward face that serves as an air and vapor barrier, simplifying construction. Seams are sealed with a special tape to maintain continuity of the air-sealed surface.

In most homes, various combinations of materials, installation methods, and air-sealing techniques are incorporated to provide for both vapor diffusion control and the control of air-transported moisture, as depicted in the appendix at the back of this booklet.

Recommended Construction, Air-Sealing & Insulating Standards

Air Leakage (Caulking and Sealing)

Air leakage is responsible for 30 percent or more of the energy loss in homes. All joints, seams and penetrations between the inside and outside of the home should be sealed. Caulk, spray foam, weather stripping and installation of a continuous building air barrier are used to address these air leaks. Stopping air infiltration is easy to do during construction, but often overlooked and covered up. As depicted in **Fig. 6**, the following areas require special attention:

1. Box sill (rim joist): use a sill sealer gasket, caulk or foam, and insulate box sill cavity.
2. Junction of foundation and sill plate: caulk or foam to subfloor or use sill sealer.
3. Junction of top plate and top of exterior walls: caulk or foam the joints.
4. Knee walls: sealed and blocked with caulk or foam.
5. Headers: caulk or foam joints on all four sides.
6. Spaces created by electric, plumbing, heating and air-conditioning service penetrations, and any other openings made in the plate: seal with caulk or foam. This includes all interior and exterior walls.
7. Switch plates, receptacles and junction boxes facing to the exterior: caulk to the exterior boxing.
8. Gaps around all HVAC register boots and openings: caulk or seal with foam to the subfloor or drywall.
9. Rough openings around doors, windows and skylights: seal with caulk, gaskets, non-expanding foam and exterior flashing tape.

10. Duct and flue shafts: seal and block with caulk or foam.

11. Shower and tub-surrounds: install a rigid air barrier between wall cavities and surrounds; caulk or foam. (Wall and ceiling cavities should be insulated prior to shower/tub installation.)

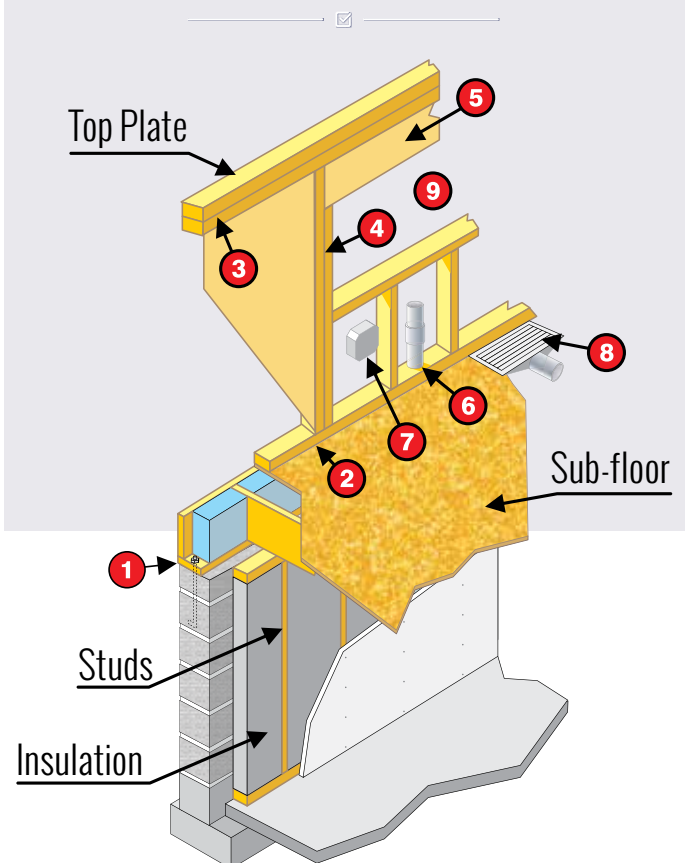

Walls

All exterior walls should be framed to avoid uninsulated air pockets, using construction methods that allow for full-depth of insulation in exterior walls. Cold corners, often caused by poor corner construction or incorrect insulating techniques, can lead to condensation in these areas; if left unchecked, mildew or mold issues can result (Fig. 7). Whether your builder uses 2x4 or 2x6 exterior wall construction techniques, insulated headers are required over doors and windows, as depicted in Fig. 8.

There are several methods that can be used to meet exterior wall insulation requirements of an Illinois Touchstone Energy Home. For information on code requirements, see the table below on insulation and fenestration requirements from the current IECC code.

For 2x6 wall construction, you may use the exterior sheathing material of your choice as long as the bare wall assembly consists of the use of a latex or enamel paint as the interior vapor barrier along with R-20 insulation in the wall cavity.

For 2x4 wall construction, continuous insulating sheathing (rigid board insulation) is required on the building exterior to maintain a consistent total sheathing thickness. The above-mentioned vapor retardant technique, along with R-13 insulation in the wall cavity, is required.

Illinois Touchstone Energy Home recommends the use of dense-packed cellulose wall insulation for newly constructed

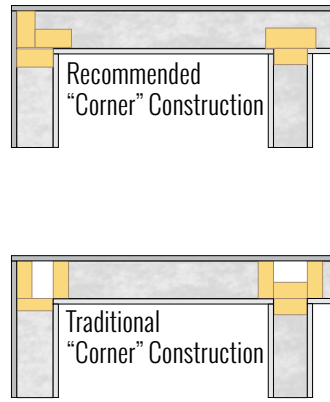

fig. 7

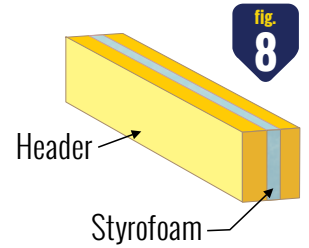

fig. 8

homes. When qualified applicators are available, we urge you to consider dense-packed cellulose wall insulation, which has been shown to be an efficient, cost-effective material for insulating exterior walls. Cellulose insulation ensures there are no uninsulated pockets in an exterior wall, and it improves air sealing and provides soundproofing. This gives cellulose an advantage: cellulose insulation types tend to retard air leakage. This helps air seal the home, thereby contributing to lower heating and cooling costs. Properly installed polyurethane spray foam insulation has many of the same advantages as cellulose, and is an outstanding insulating and air-sealing product. However, it generally is more expensive to install.

Insulation and Fenestration Requirements by Component^a

For more details, please refer to current IECC code.

fig. 9

CLIMATE ZONE	FENESTRATION U-FACTOR ^b	SKYLIGHT ^b U-FACTOR	GLAZED FENESTRATION SHGC ^b	CEILING R-VALUE	WOOD FRAME WALL R-VALUE	MASS WALL R-VALUE	FLOOR R-VALUE	BASEMENT ^c WALL R-VALUE	SLAB ^d R-VALUE & DEPTH	CRAWL SPACE ^e R-VALUE
5 and Marine 4	0.30	0.55	NR	49	20 OR 13+5 ^h	13/17	30 ^g	15/19	10, 2 ft	15/19
4 except Marine	0.32	0.55	0.4	49	20 OR 13+5 ^h	8/13	19	10/13	10, 2 ft	10/13

CLIMATE ZONE 5

Adams	De Witt	Jo Daviess	McDonough	Sangamon
Boone	Douglas	Kane	McHenry	Schuyler
Brown	DuPage	Kankakee	McLean	Scott
Bureau	Edgar	Kendall	Menard	Stark
Calhoun	Ford	Knox	Mercer	Stephenson
Carroll	Fulton	La Salle	Morgan	Tazewell
Cass	Greene	Lake	Moultrie	Vermilion
Champaign	Grundy	Lee	Ogle	Warren
Clark	Hancock	Livingston	Peoria	Whiteside
Coles	Henderson	Logan	Piatt	Will
Cook	Henry	Macon	Pike	Winnebago
Cumberland	Iroquois	Marshall	Putnam	Woodford
DeKalb	Jersey	Mason	Rock Island	

CLIMATE ZONE 4

Alexander	Jackson	Pulaski	Union
Bond	Jasper	Randolph	Wabash
Christian	Jefferson	Richland	Washington
Clay	Johnson	Saline	Wayne
Clinton	Lawrence	Shelby	White
Crawford	Macoupin	St. Clair	Williamson
Edwards	Madison		
Effingham	Marion		
Fayette	Massac		
Franklin	Monroe		
Gallatin	Montgomery		
Hamilton	Perry		
Hardin	Pope		

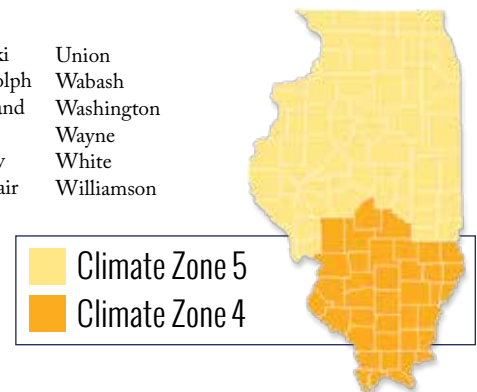

! Touchstone Energy Home recommends dense-packed cellulose insulation in the exterior walls, as a best practice. By comparison, fiberglass batt insulation is more prone to air leakage, while cellulose insulation helps eliminate leakage. However, if fiberglass batt insulation is used, proper installation is essential.

If installing fiberglass batts, it is necessary to cut the insulation to fit around obstructions. Battas are never to be compressed behind wiring, plumbing or other obstructions, as this greatly diminishes the insulating performance of the batts.

Fig. 9 shows the right and wrong ways of installing fiberglass insulation.

Examples of improper installations are:

- (a) Battas that have been compressed behind wiring, plumbing and other obstructions;
- (b) Battas improperly cut to fit the opening;
- (c) Battas not installed to the top or bottom of the stud cavity;
- (d) Battas not fitting snugly together;
- (e) Battas installed in an unsealed wall cavity (e.g., lacking six enclosing sides).

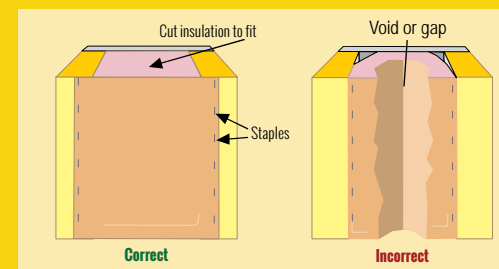

Basement Walls

Many people think that since their basement might be unfinished or only used for storage, it's an "unconditioned" space that doesn't need to be insulated. But in most cases, a supply diffuser is located to temper the space, or the basement is indirectly heated, as it is not thermally isolated (insulated) from the conditioned living space above. Accordingly, insulation is required on the basement walls. A basement is unconditioned only if the floor above the basement is insulated to R-30; the walls of the stairs leading to the basement are insulated to the levels required for exterior walls; the door leading to the basement from the conditioned living space above is insulated and weather stripped; no duct registers are located in the basement and all ducts exposed to the basement are sealed and insulated to R-8.

Exterior walls in conditioned basements are to be insulated to R-13 minimum. This can be done by framing out the walls and using either sprayed or rigid foam board insulation. Rigid foam board can be fitted and sealed in the framing cavities, or attached to the wall behind the framing lumber.

New - Basement Wall (**Fig. 10** and **Fig. 11**): When insulating the basement or crawl space, do not forget to insulate the box sill (rim joist) to the R-value required for exterior walls. Moisture control should be considered as basements and crawl spaces tend to be exposed to relatively high levels of water vapor. Insulating materials should prevent moisture from being carried to the cold wood, which can cause

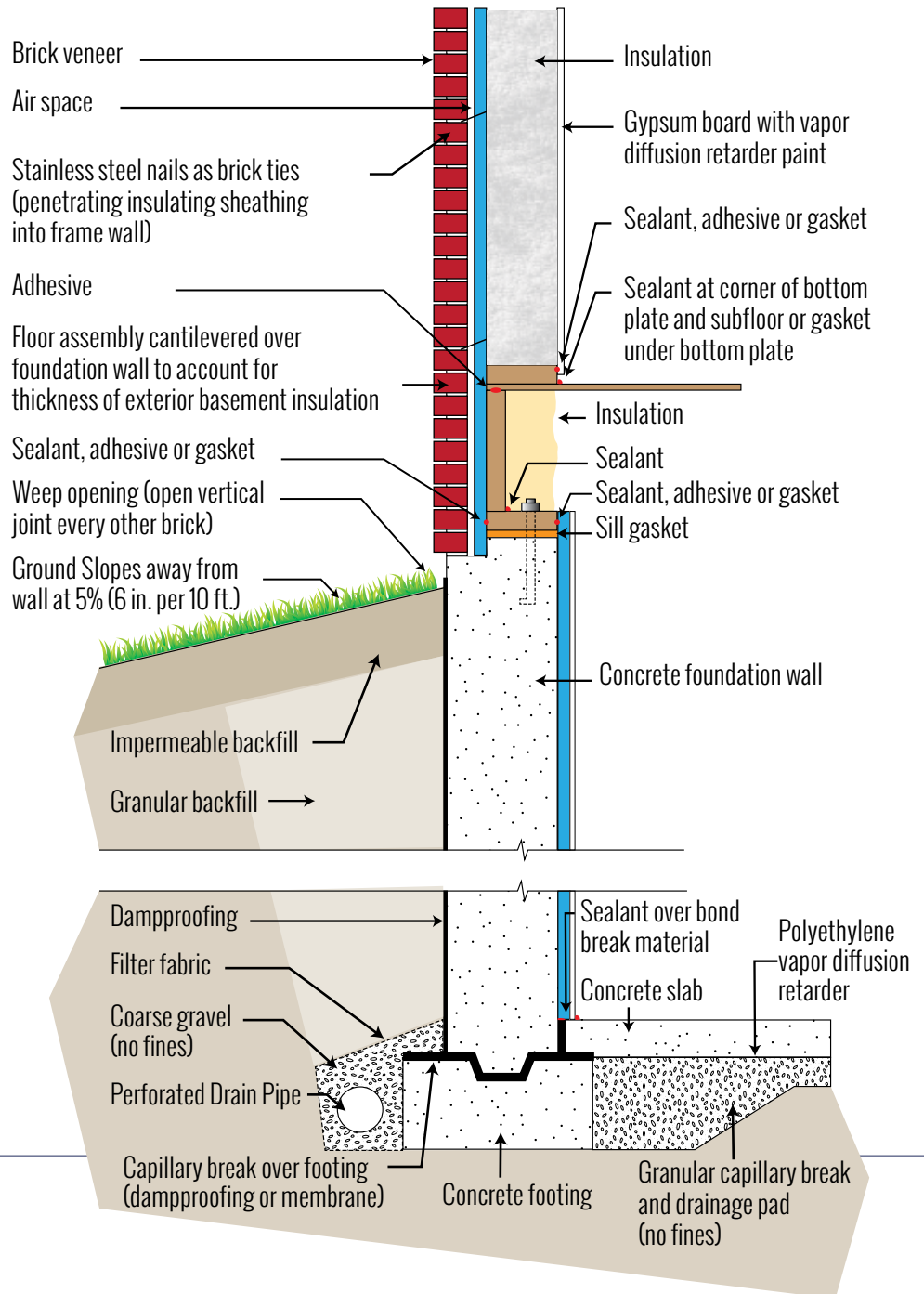

fig. 10

When insulating the basement or crawl space, do not forget to insulate the box sill.

rot and decay. Another area similar to the box sill is the band joist in two-story construction. The band joist must also be insulated to the same R-value as the exterior walls above and below it. Illinois Touchstone Energy Home recommends foam insulation in the box sill and band joist as the best practice.

Structural Insulated Panels

An alternative to standard framed construction is called structural insulated panels or SIPs. These are engineered panels of insulating foam sandwiched between two pieces of rigid material – plywood, OSB (or wafer-board), gypsum wall board or sheet metal. Manufactured in many sizes, structural insulated panels are available for residential wall construction in 4' x 8' sheets and larger.

Structural insulated panels are engineered and constructed to act as T beams. They are extremely strong, resist bending and buckling and are load-bearing. They can be used as sub-flooring over crawl spaces for insulated floors and can deaden sound. They can also be used in roof and ceiling construction.

Structural insulated panel walls have higher R-values than their comparable, framed-wall counterparts. With fewer joints to seal there is a low air infiltration rate.

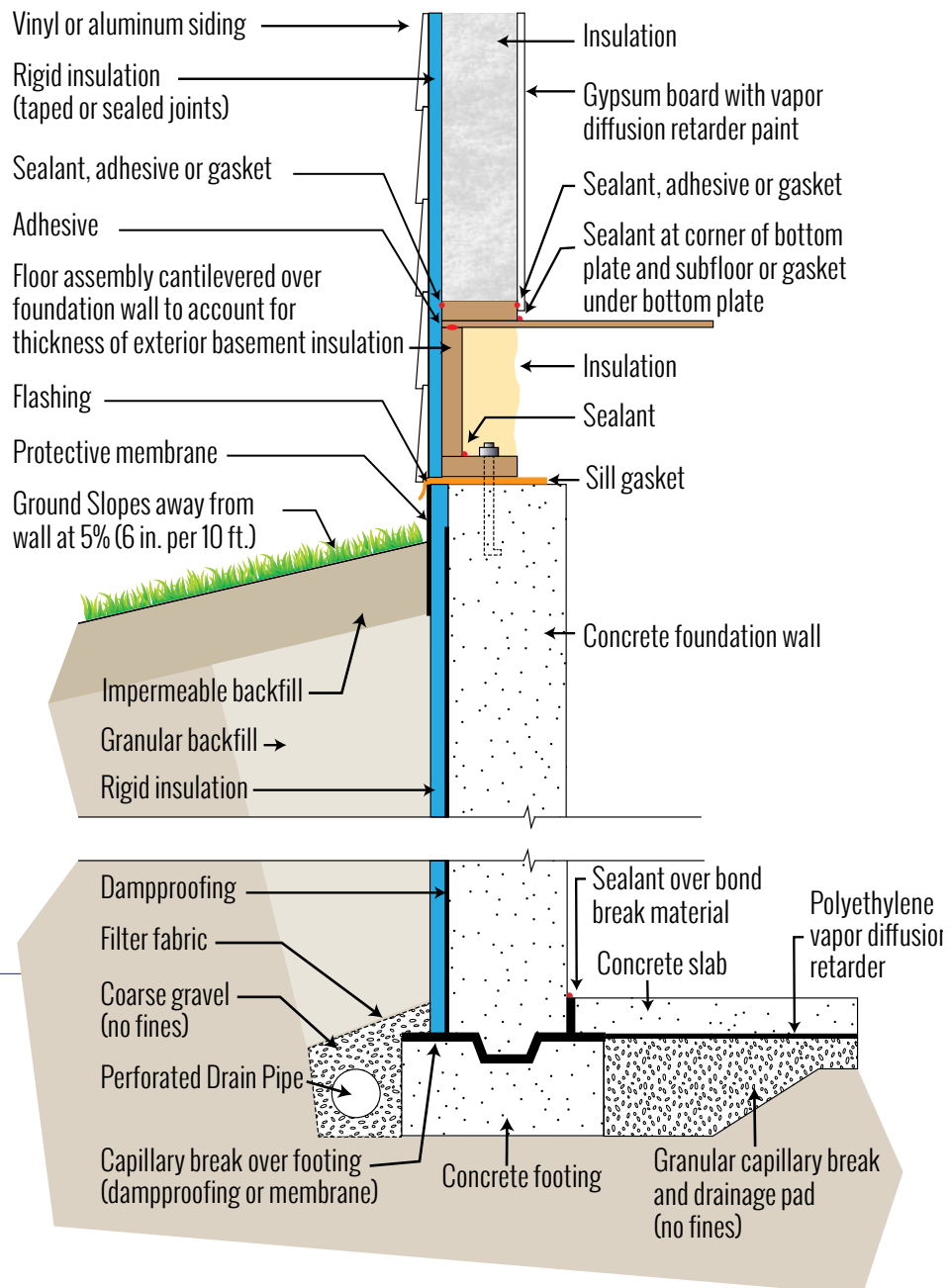
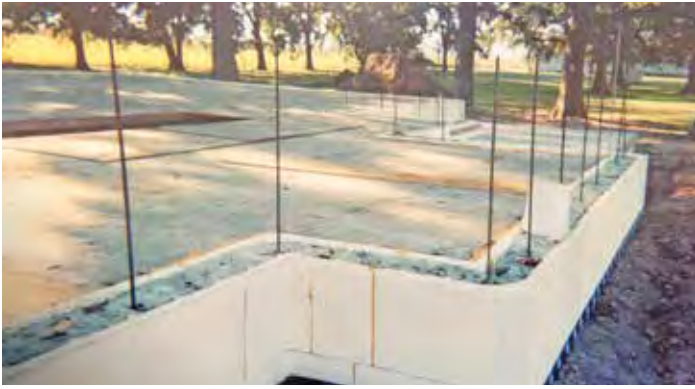

fig. 11

Fig. 10 & 11
Proper wall construction methods above and below grade

Insulated Concrete Forms



Insulated concrete forms (ICF) can be used in place of traditional forms when pouring concrete for basement wall construction. They can also be used for above grade wall construction as desired. Made with expanded polystyrene, ICFs often result in walls with insulating values of R-20 and higher. Most homeowners plan to insulate and finish their basement later, but end up with a cold basement and high heating bills. Insulated concrete forms avoid this problem.

As the concrete core of an ICF wall is connected to the footing, it is important that ICF wall footings are installed deep enough to ensure the footing isn't exposed to freezing temperatures that can wick heat from the wall core. Installers should follow the manufacturer's recommendations for footing depth.

There are two types of ICF systems: rigid sheets of foam board held together with plastic or metal ties, and interlocking, stackable foam blocks. Reinforcing steel can be added as needed. Furring strips are provided so that wall finish materials can be added later.

Steel Framing

When the price of wood products increases, builders look for alternatives. One alternative to standard wood studs is steel framing. As a reusable and recycled product, steel framing has several advantages, such as price stability and consistent size. Steel framing is lighter, does not twist, shrink or warp and is not affected by termites.

Unfortunately, steel framing has one fatal flaw – it is prone to conductive heat loss. The thermal bridging created by steel framing lowers the effective R-value of the wall by as much as 50 percent. The best alternative is to install insulated sheathing in a continuous manner on the entire exterior surface of the wall. We do not recommend steel framing for an Illinois Touchstone Energy Home.

Blower Door Test

Home builders must demonstrate they have sealed air leaks in new homes by performing a blower door test (Fig. 12). The Illinois Energy Conservation Code requires blower door testing in new homes. Having a home professionally inspected and/or tested is an important safeguard for consumers. New home owners should have a copy of the test results. New homes constructed in Illinois after July 1, 2019, must demonstrate a tested air leakage rate of four air changes per hour (4.0 ACH) or less when measured with a blower door at a pressure of 0.2 inches w.c. or 50 Pascal (50Pa).



Roof/Ceiling Construction and Ventilated Attics



Illinois Touchstone Energy Home recommends loose-blown cellulose in the attic to provide uniform insulation coverage with minimal air movement problems.

Roof pitches greater than or equal to 6-in-12 are recommended. This allows for fewer restrictions at the eaves and provides for better attic ventilation. As the roof deck is steeper, air will be easily directed via eave openings and ventilation baffles to the peak, where it can exit through the ridge vents. The additional height also allows for better working conditions in the attic. In a roof with less than a 6-in-12 pitch, much of the ceiling will have less insulation than recommended because conventional rafter and truss construction tends to compress roof/ceiling insulation levels at the roof eave-wall line interface. Raised-heel or energy truss construction allows for fully developed depth of roof/ceiling insulation, eliminating the reduction in roof/ceiling effective R-values caused by compression of the insulation, as shown in **Fig. 13**. For information on attic insulation requirements, see the insulation and fenestration chart from the current IECC code book.

The number of openings through the ceiling should be minimized to maintain air barrier integrity of the building and achieve low energy consumption. Attic access doors and

scuttles should be placed in unconditioned areas, such as the garage. If this is not possible, access doors are to be insulated and weather stripped at level required for ceiling (see **Fig. 9**). Typical methods are shown in **Fig. 14** and **Fig. 15**. Whole-house attic fans are not recommended. Easy access in the attic should also be provided, such as a catwalk, as shown in **Fig. 16**.

Soffits in kitchens and bathrooms should be constructed after the ceiling and walls have been installed and enclosed. This will maintain the integrity of the ceiling surface. Any recessed lighting that is used should be installed in a sealed soffit area (i.e., not communicating with the unconditioned attic). If recessed lighting cannot be installed in this manner, lights must be labeled “air-tight” and IC-rated (suitable for insulation contact) or have insulated, air-tight boxes constructed to cover and enclose them.

All attics above conditioned spaces are to be insulated to a minimum R-49. Where raised-heel truss construction is utilized, this insulation level can be reduced to R-38. Insulating materials must extend completely over the top plate of walls at the attic perimeter to eliminate cold corners in rooms below. Illinois Touchstone Energy Home recommends that knee walls or any wall exposed to the ventilated attic area be insulated to

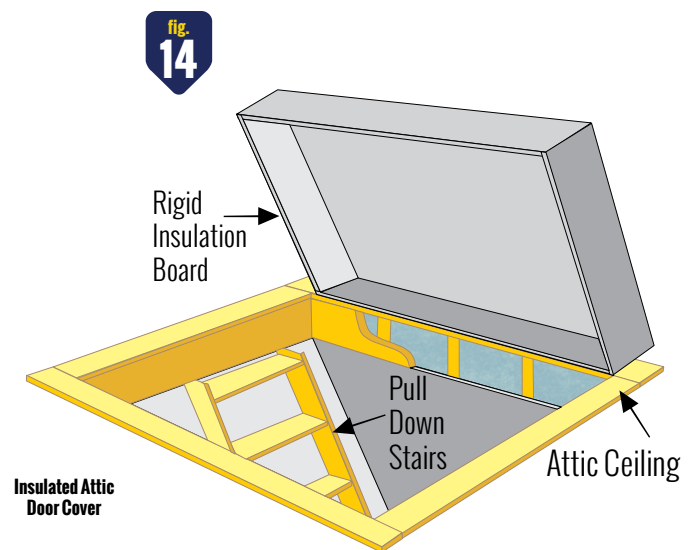
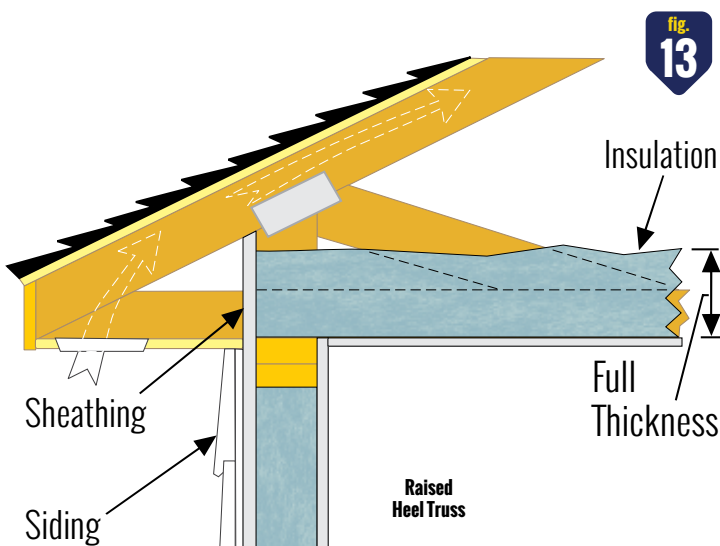

the level required for attics. Attics can reach extreme temperatures in both winter and summer months. Fiberglass insulation, either batt or loose-fill, is not recommended for use in any attic space. Fiberglass batts, although not recommended, if used must be trimmed and cut to fit snugly around obstructions, such as exhaust fans and truss members. To avoid these problems, Illinois Touchstone Energy Home recommends that loose-fill cellulose insulation be used for roof/ceiling and attic locations.

Attics must have proper ventilation, not only to help reduce temperatures during the summer, but also to allow any moisture that may build up in the winter to escape. Adequate attic ventilation is crucial to the overall energy efficiency performance of the home.

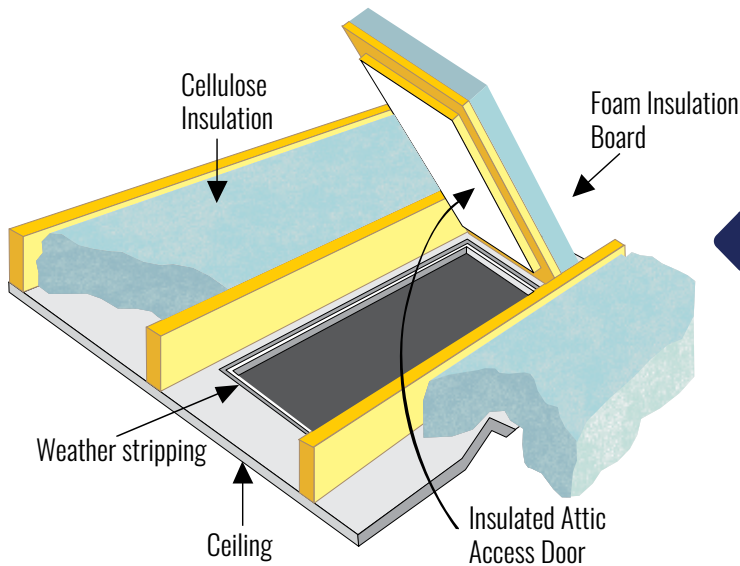

fig. 15

One last suggestion: some homeowners and builders may use tongue-and-groove wood for ceiling construction. This application does not provide a proper air seal by itself, as wood often cracks and shrinks with time. If using wood on the ceiling, apply it over a properly taped and sealed drywall surface.

In the attic, eave baffles of any solid material should be installed adjacent to soffit and eave vents and extending over the top of the attic insulation. Eave baffles keep air movement from air-washing the insulation (reducing its R-value) or blowing away loose-fill insulation types from the attic perimeter. Ventilation openings should include soffit vents as well as ridge vents or static vents, as shown in **Fig. 17**.

A passageway should be provided to permit access through the attic without compressing the insulation. For attic storage, expand the areas as illustrated.

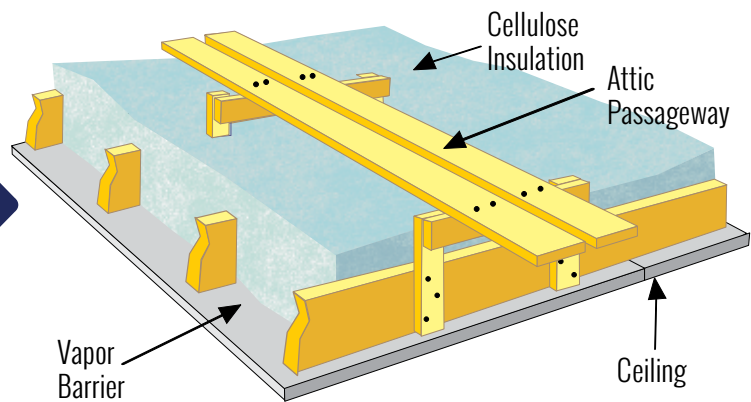

fig. 16

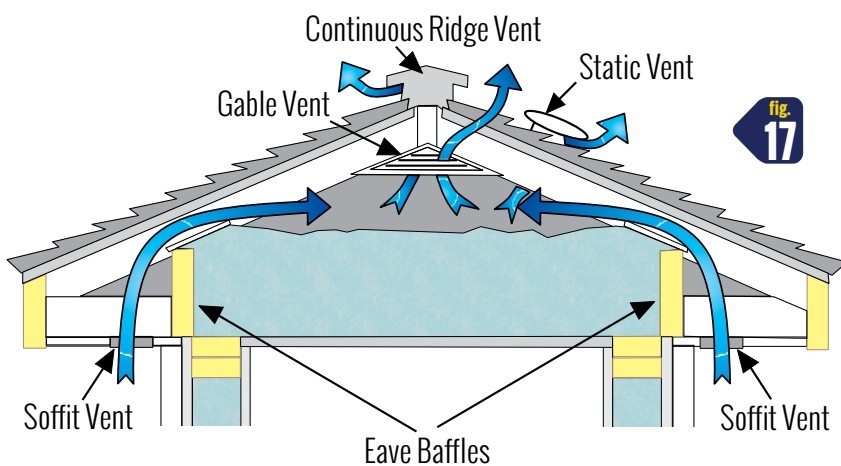

fig. 17

Properly sized inlets and outlets must be provided to allow air circulation through the attic. If a continuous ridge vent is not installed, then roof or gable vents should be used.

Floors



The floors above unconditioned basements, ventilated crawl spaces and unconditioned garages are to be considered as part of the building thermal envelope and shall be air sealed and insulated at levels required for floors (see **Fig. 9** on page 7) accordingly. All openings in the floor surface are to be sealed and closed off. This includes openings for duct systems (especially register boots), electrical, telephone, security and CATV wiring systems, as well as plumbing and fuel gas-piping systems. The drain area for bathtubs and showers is especially important, as these are normally very large openings.

Where the garage ceiling is part of the building thermal envelope with the garage ceiling being the floor for the conditioned living space above, an air-tight barrier is required to prevent the migration of automobile exhaust gasses into the living space.

Floors Over Crawl Spaces

Floors over unconditioned crawl spaces should be insulated to a level of insulation sufficient to fill the floor joist depth (see **Fig. 9** on page 7). To accomplish this, insulation is installed between the floor joists with sufficient support provided such that the insulation maintains permanent contact with the underside of the subfloor.

Where water lines, heating and/or air-conditioning ducts are present in the crawl space, it may be best to insulate the crawl space walls rather than the floor/ceiling above to prevent pipes from freezing and energy losses through uninsulated ducts. Illinois Touchstone Energy Home recommends the use of spray or rigid foam on crawl space walls.

A 6-mil polyethylene plastic, continuous ground-covering material must be installed on the floor of the crawl space to prevent ground moisture from entering the crawl space area, as shown in **Fig. 18**. This barrier must be turned up the sides of the walls at least 6 inches and sealed, with joints also lapped at 6 inches and sealed. Crawl space wall ventilation openings are prohibited where crawl space walls are insulated. In such a case, the crawl space shall be conditioned or mechanically ventilated in accordance with the building code.

Concrete Slab Floors

Eight inches of concrete has roughly the same insulating value as a single pane of clear glass. Accordingly, the perimeter of concrete slab floors on or at grade are often subject to significant temperature extremes (and high levels of heat loss), particularly at the slab edge. Concrete slab floors less than 24 inches below grade (including walk-out basements), must have

their perimeter insulated. This can be done by installing rigid foam board insulation downward from the top of the slab on the outside or inside of the foundation wall; or downward to the thickness of the slab, then inward, horizontally from the perimeter (see **Fig. 19**). Where heating elements, hydronic tubing or hot air distribution systems are in contact with, or placed within or under the slab, Illinois Touchstone Energy Home recommends the entire area below the concrete be insulated with minimum R-5 rigid foam board.

For insulation depths in all floor applications, please refer to chart from current IECC.

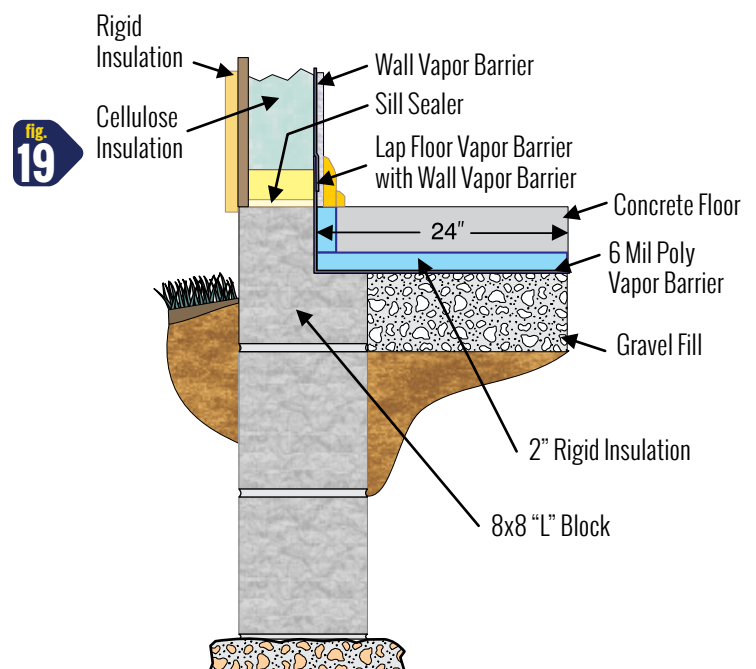
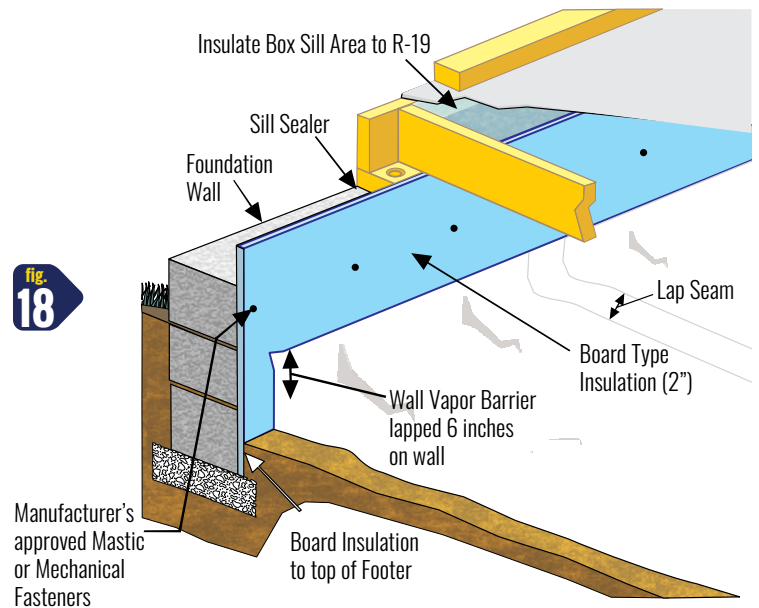

Windows & Doors



Although windows and doors can add to the overall appearance of your home, they very seldom add to the overall energy efficiency as they are made of glass, wood, vinyl and aluminum, which are considered poor insulating materials. Because they are such a large source of energy loss, and just as much of an opportunity for improving the comfort of your home, the quality of the doors and windows you select should not be sacrificed to bring the building energy savings budget back in line.

Casement and awning-type windows generally have less air infiltration than slider and double-hung windows, and should be considered if they meet the design and architectural style of the home. Most window manufacturers now use a rating system developed by the National Fenestration Rating Council (NFRC). This NFRC rating provides a standardized method of comparing window performance. (See **Fig. 20**.) Your building center or builder can furnish you with this information. One rating standard is U-factor. U-factors are used to indicate the insulating value of doors and windows. Unlike R-value, the lower the U-factor the higher the insulating value.

Because windows and glass doors are major areas of heat loss and heat gain, Illinois Touchstone Energy Home recommends they should be sized so they are no more than 10 percent of the conditioned floor area of your home. In other words, if you are building a 2,000-square-foot home, the total area windows and glazed doors should be less than 200 square feet.

Windows that face east or west should be kept to a minimum. As the sun rises and sets in these directions, these windows are subject to direct rays from the sun at low angles and can lead to high heat gains in the summer months—making your air-conditioner work harder. In fact, it has been estimated that a window facing west can add as much as a 1/2 ton (6,000 BTUh) of cooling requirement to the house. Windows that must face these directions should be shaded with deciduous trees, blocking the sun in the summer, but allowing the sun's warming rays to strike the window in the winter.

EXAMPLE

	<p>World's Best Window Co.</p> <p>Millennium 2000⁺ Vinyl-Clad Wood Frame Double Glazing • Argon Fill • Low E Product Type: Vertical Slider</p>
ENERGY PERFORMANCE RATINGS	
<p>U-Factor (U.S./I-P)</p> <p style="text-align: center;">0.32</p>	<p>Solar Heat Gain Coefficient</p> <p style="text-align: center;">0.32</p>
ADDITIONAL PERFORMANCE RATINGS	
<p>Visible Transmittance</p> <p style="text-align: center;">0.51</p>	<p>Air Leakage (U.S./I-P)</p> <p style="text-align: center;">0.32</p>
<p><small>Manufacturer stipulates that these ratings conform to applicable NFRC procedures for determining whole product performance. NFRC ratings are determined for a fixed set of environmental conditions and a specific product size. Consult manufacturer's literature for other product performance information. www.nfrc.org</small></p>	



South-facing windows are excellent where ample overhang is provided to shade the window in the summer months. As the angle of the sun falls lower in the winter, the sun's warming rays can still pass through the window on sunny winter days, contributing heat energy to the home, but are blocked during the summer. Deciduous trees are again excellent for this purpose.

Windows, at a minimum, must be double-pane, low-e glass, and have an NRFC-tested U-factor of 0.32 or lower.

Low-e windows have a thin coating that reflects some of the sun's ultraviolet rays during the summer, helping to reduce heat gain as shown in **Fig. 21**. It also reflects some heat back

fig. 21

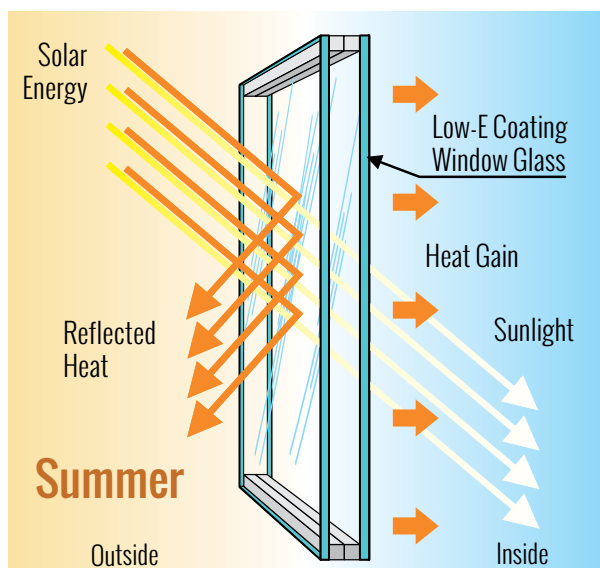
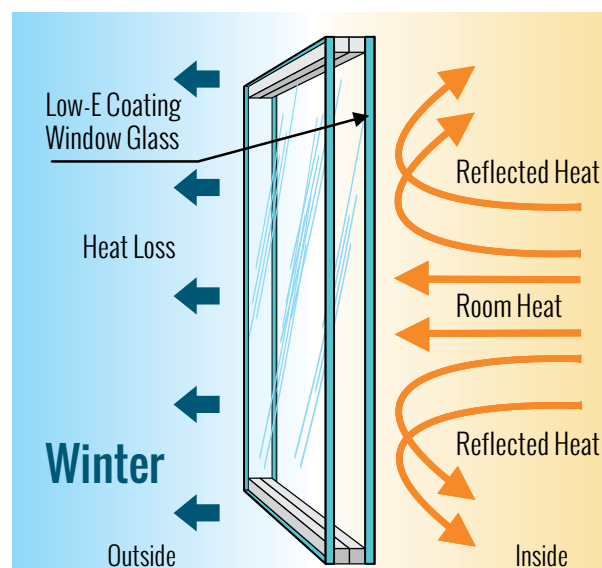

fig. 22



into the conditioned living space in the winter, as shown in **Fig. 22**. It is recommended that you consider purchasing windows with an inert gas between the panes of glass. Gases such as argon, krypton and xenon are often used since (at normal temperatures) they do not transfer as much heat compared to air.

Two types of windows that need special attention are bow and bay windows. Since these windows have a ceiling and floor to them, they need to be insulated to the required ceiling and floor levels. Particular attention should also be given to the need for controlling air infiltration with these types of windows. Caulk, spray foam and exterior flashing tape must be used to seal any cracks in framing and siding materials. Garden windows are not recommended as they are prone to condensation and heat loss concerns.

All doors that separate conditioned areas from uncondi-

tioned areas are to be insulated and have weather stripping installed (see **Fig. 23**). This includes doors that lead from the conditioned living space to the unconditioned garage. Thresholds must be caulked with continuous beads to the sub-floor. Metal or fiberglass doors with a foam core and a thermally broken door frame are recommended. Glass area in exterior doors should be kept to a minimum, and all recommendations concerning windows apply to the glazed areas of exterior doors.

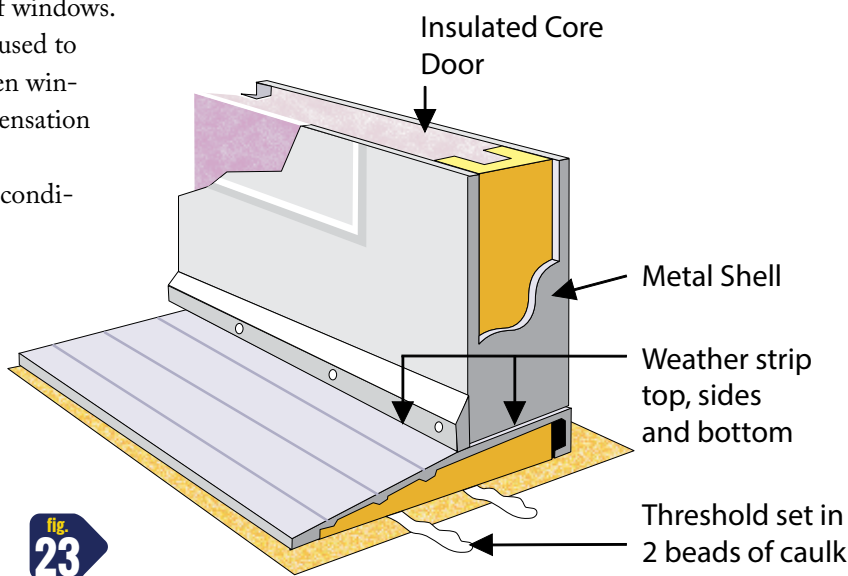

Heating, Ventilation & Air-Conditioning Systems (HVAC)



System Selection

Your home's HVAC system(s) not only consumes huge amounts of the total energy budget, but also impacts the comfort and well-being of the occupants (your family) more than any other system in the home. Accordingly, the more efficient the system that is installed, the lower your annual operating costs will be. The most cost-competitive method for heating and cooling your home is the geothermal heat pump, with the second being a high-efficiency, air-to-air heat pump. Geothermal and air-to-air heat pumps, which move heat energy rather than create it, are typically up to four times more efficient than gas furnaces.

Illinois Touchstone Energy Home recommends the installation of a geothermal heat pump in all new homes.

A geothermal heat pump is an extremely efficient, year-round heating and cooling system. It uses a ground loop system to transfer heat to and from your home (See **Fig. 24** and **Fig. 25**.) According to the U.S. Environmental Protection Agency (EPA), geothermal systems are the most energy efficient, environmentally clean, and cost-effective space conditioning systems available.

In addition to space conditioning, geothermal heat pumps can be used to provide domestic hot water when the system is oper-

ating. Most residential systems are equipped to transfer excess heat from the geothermal heat pump to the house's hot water tank, often saving 50 percent or more on water heating costs.

A frequent question asked about geothermal heat pumps is how long it will take to recoup the investment. In general, the incremental payback for residential geothermal systems is typically 2-5 years. The incremental payback is the additional cost of geothermal versus a traditional HVAC installation; reduced energy costs will lead to a payback of this additional investment, typically in 2-5 years. An accurate payback calculation can be provided by a qualified heating-cooling contractor or electric cooperative energy professional.

Moreover, instead of looking at the time it takes for payback, consider a simple monthly cash flow analysis. The additional monthly mortgage payment for the investment in a geothermal heat pump will be less than the savings generated every month by using the geothermal system, providing a positive cash flow each month.

An air-to-air heat pump operates similarly to a geothermal heat pump, except it does not have a ground loop system. It absorbs or rejects its heat to or from the outside air. Illinois Touchstone Energy Home recommends that air-to-air heat pumps have a minimum efficiency in cooling mode of at least 16 SEER (Seasonal Energy Efficiency Ratio).

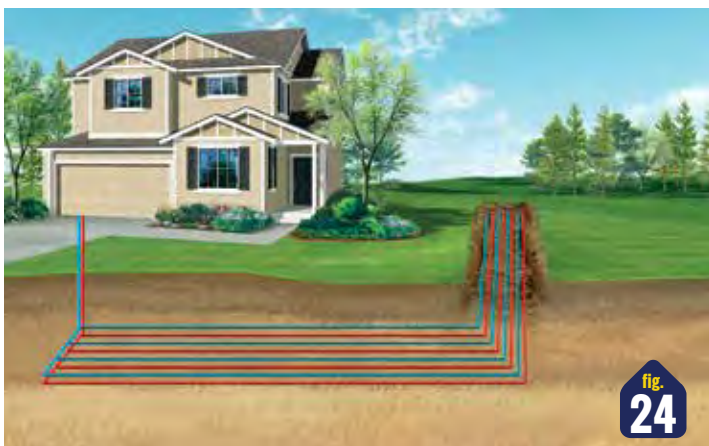

Two popular forms of geothermal closed loop systems are shown in these figures. **Fig. 24**, left, is a horizontal system, with loops installed in a 5-8 foot trench. **Fig. 25** is a common vertical loop system, where loops are installed in vertical boreholes at depths of 150-200 feet or more.

Controls

Programmable thermostats can generate annual energy savings of up to 10 percent depending on fuel type. Homes with gas furnaces must have programmable thermostats installed. Regardless of the heating and cooling system in a home, programmable thermostats can save money and energy.

Heat pumps having supplemental electric-resistance heat must have controls that, except during defrost, prevent supplemental heat operation when the heat pump compressor can meet the heating load.

Woodburning appliances and gas fireplaces are not recommended by Illinois Touchstone Energy Home. If woodburning or gas fireplaces are installed in the home, they must be provided with a tight-fitting flue damper, and combustion air shall be supplied from the outdoors. Alternatives to wood or gas fireplaces are electric fireplaces or sealed combustion, gas log fireplaces.

System Sizing

Improper sizing and installation of heating and air conditioning equipment can waste significant energy and result in costly utility bills. Your heating and cooling equipment must be sized according to the professional standards of Air Conditioning Contractors of America (ACCA) Manual S, based on loads calculated in accordance with ACCA Manual J.

Duct and Air-Handling Systems

All ducts, air handler cabinets and filter manifolds are to be insulated and sealed. Leaky ducts can be responsible for 10-30 percent of energy loss in a home. Ducts within the building thermal envelope should be sealed and insulated to R-6. Illinois Touchstone Energy Home recommends ductwork should not be installed in unconditioned spaces, such as attics and ventilated crawl spaces, or located within building thermal envelope components (i.e., the floor/ceiling separating an unconditioned garage from the conditioned living space above). All ducts that must be located outside the thermal envelope need to be sealed and insulated to a minimum of R-8.

All ducts and air handlers are to be sealed with mastic (a special type of durable caulk that is easily visible); unlisted “duct tapes” are no longer recognized as a sealant. Either UL 181-listed foil tapes or mastics are preferable as they will stand the test of time and help reduce energy wasted by air leaking to unoccupied areas of the home. Without proper sealing, your system will simply be heating (or cooling) the attic or crawl space – wasting considerable energy. In existing homes, leakage should be assumed, and mastic should be applied along every joint, seam and connection.

Ventilation equipment, range hoods, ventilation fans, dryer exhaust, etc., must be equipped with back-draft dampers installed in the duct system and connected directly to the exterior. Clothes

dryer exhausts must not be directed to the interior living space, as the additional moisture, and sometimes by-products of combustion (gas dryers), introduced into the home can be detrimental.

Ducts must be tested and verified to have total leakage of no more than 4 CFM/100 square feet of conditioned space, or 3 CFM/100 square feet of conditioned space if air handler is not installed, except where handler and all ducts are inside conditioned space. This is a total air leakage test – meaning that all ducts in both conditioned and unconditioned spaces must be tested to the standard above.

Ventilation Air Requirements, CFM
Continuous Whole-House Ventilation System Airflow Rate Requirements

Floor Area (ft ²)	0-1 Bedrooms	2-3 Bedrooms	4-5 Bedrooms	6-7 Bedrooms	7+ Bedrooms
<1,500	30	45	60	75	90
1,500 - 3,000	45	60	75	90	105
3,001 - 4,500	60	75	90	105	120
4,501 - 6,000	75	90	105	120	135
6,001 - 7,500	90	105	120	135	150
>7,500	105	120	135	150	165

fig. 26

Whole-House Mechanical Ventilation

In the past, no specific requirements for ventilation were imposed for residential buildings. Natural ventilation (a presumed amount of natural air exchange between indoors and outdoors resulting from loose building construction) was considered adequate to maintain indoor air quality. As envelope construction practices have improved, the need to deliberately introduce fresh, outdoor air to homes by mechanical means has increased.

Residential buildings tested and verified as having an air leakage rate less than 5.0 ACH50 (five air changes per hour) are required to install a whole-house mechanical ventilation system, individual exhaust fans, or a combination of such. Outdoor air ducts connected to the return side of an air handler shall be considered to provide supply ventilation.

Illinois Touchstone Energy Home recommends a heat or energy recovery ventilator (HRV/ERV) for mechanical ventilation. Recovery ventilators will exhaust stale air, but recover most of the BTUs to pre-warm or pre-cool incoming fresh air.

However, the whole-house mechanical ventilation system can be designed to operate intermittently where the system has controls that enable operation for not less than 25 percent of each four-hour segment, and the ventilation rate prescribed in Table R403.6.4.3(1) (Fig. 26) is multiplied by the factor determined in accordance with Table R403.6.4.3(2) (Fig. 27) of the Illinois Amendments to the 2018 IECC.

Intermittent Whole-House Mechanical Ventilation Rate Factors

Run-Time Percentage in each 4-Hour Segment	25%	33%	50%	66%	75%	100%
Factor	4.0	3.0	2.0	1.5	1.3	1.0

fig. 27

Domestic Hot Water

Depending on the appliances, the number of occupants and the living habits of the occupants, energy consumption for the domestic hot water systems of your home can be substantial. It is the second highest energy user in the home after space conditioning. The following suggestions will help lessen energy consumption:

1. Water heaters should be set at no higher than 120 degrees Fahrenheit.
2. Dishwashers should be ENERGY STAR qualified where an ENERGY STAR category exists for the specific dishwasher type. Oftentimes, this means the dishwasher is limited by maximum water consumption standards and often equipped with a pre-heater to raise the temperature of the water only to the higher temperatures needed for sanitation of dishes.
3. All domestic hot water pipes should be insulated to a minimum level of R-3. It is suggested that the domestic hot water tank be placed on a piece of 2-inch foam board.

4. All water heaters should be placed as near the point of usage as possible and anchored to a wall or floor for seismic restraint.

5. Homes with a geothermal heat pump should have a desuperheater installed with the water heater. In this application, there should be two water heaters installed. One will serve as a buffer tank, preheating the water for the primary water heater. This buffer tank should be connected to the geothermal unit with a desuperheater connection. This desuperheater utilizes waste heat from the geothermal unit to provide a water heating boost, vastly increasing the overall energy efficiency of the domestic water heating system.

6. Use low-flow showerheads and faucets.

Lighting

Lighting can have a significant impact on the energy use in homes. Select LED (light-emitting diode) lamps wherever possible. They are initially more expensive, but LED lamps use much less energy, are less expensive to operate, and last longer than incandescent lamps. LED lamps are available for many applications – and they create less heat than incandescent bulbs. At least 90 percent of lamps in permanently-installed

fixtures must be high-efficiency.

As mentioned earlier, recessed lights should be installed in soffits and not directly in the ceiling (i.e., punching through the building air barrier and into the unconditioned attic above). If soffits are not practical, airtight, recessed fixtures or surface track lighting are better choices.

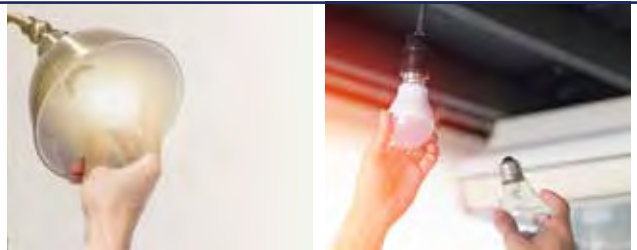

Energy Certificate

All new homes must have a builder's Energy Certificate (Fig. 28) on or in the circuit breaker box (i.e., electrical distribution panel) listing the materials and equipment values and ratings that demonstrate that a new home meets the IECC provisions. The certificate is an important means by which the consumer can verify that the home complies with the code.

fig. 28

Energy Efficiency Certificate			
Permit No. _____			
Address _____			
Insulation Ratings		R-Value	
Roof/Ceiling	Without attic #	49	
Walls	Frame #	13	
	Mau #		
	Exterior #	16	
Floor	Crawlpace #	11	
	Over unconditioned space		
Ducts	Attic #		
	Basement #		
Penetration Ratings	NFRC U-Factor		
	NFRC SHGC		
Opaque doors	U-0.18		0.07
Windows	U-0.26		
Skylights	U-0.44		
Equipment Performance		Efficiency	
Heating system	NA Gas	HSPF/AFLUE	9.8
Cooling system		COP/SEER	13.0/13.0
Water Heater/Bolan	EFIE or E		0.63
Builder/Designer: _____			
Certified by: _____		Date: _____	
Accepted Code Edition: _____			
THIS CERTIFICATE SHALL BE PERMANENTLY POSTED ON OR IN THE ELECTRICAL DISTRIBUTION PANEL AS REQUIRED BY ENERGY / RESIDENTIAL CODES			

Conclusion

Providing you with the information and construction techniques to live comfortably and economically in your new home is the objective of the Illinois Touchstone Energy Home program. If you build or have someone build your new home using these standards, we are certain that your home will provide you with the best comfort available with little additional investment and will also be energy efficient.

The importance of paying attention to detail and application during the construction process cannot be understated. Though some of the items presented in this manual seem insignificant, it is the use of the total concept that provides for large energy savings. Careless installation and lack of attention to detail can cause even the best-laid plans to go awry.



Should you have any questions concerning the ideas presented in this manual or desire more detailed information, contact your local electric cooperative. You may also want to contact your cooperative for information concerning any special energy programs that may be available.

Please understand that advances in material and technology are occurring constantly. There may be alternative construction methods that meet these standards. This manual has been prepared based upon material and information that is currently available. Your electric cooperative is a valuable source of information concerning new advances in construction and equipment and should be contacted concerning new developments.

Summary-Construction Specifications

Walls:

1. For 2x4 wall construction, there are two basic methods with various product options for cavity insulation types available:
 - a. A base wall assembly consists of the use of latex or enamel paint as the interior vapor diffusion barrier, along with R-13 insulation in the cavity. Illinois Touchstone Energy Home recommends the installation of dense-packed (R-3.5/inch) wet-spray cellulose, or spray-foam insulations and continuous R-5 continuous insulating sheathing (rigid board insulation) on the building exterior. Where structural sheathing (OSB—Oriented Strand Board) covers 40 percent or less of the exterior, the R-5 insulating sheathing may be reduced to R-2 insulating sheathing in the locations where structural sheathing is used—to maintain a consistent total sheathing thickness.*
 - b. Where structural sheathing (OSB) covers more than 40 percent exterior, the base wall assembly shall be a latex or enamel paint vapor diffusion barrier and R-13+5ci sheathing covering the entire exterior wall assembly. In other words, no reduction in the exterior continuous insulating sheathing thickness is permitted.
2. For 2x6 wall construction, you may use the exterior sheathing material of your choice provided:

The base wall assembly consists of the use of latex or enamel paint as the interior vapor diffusion barrier, along with R-20 insulation in the cavity (as recommended by Illinois Touchstone Energy Home), dense-packed (R-3.5/inch) wet-spray cellulose, or spray-foam insulations, installation of ventilated cladding over wood structural panels, fiberboard or exterior-grade gypsum wallboard, and a house wrapping air barrier on the exterior.

All walls will have new framing techniques for corner and partition posts, and insulated headers over doors and windows.

Basement Walls:

All heated basement walls insulated to R-13 minimum.

Box sills (rim joists) and band joists insulated to the level required for exterior walls.

Ceilings:

All ceilings insulated to R-49. Where raised-heel truss construction is utilized, this insulation level can be reduced

* Illinois Touchstone Energy Home relies on building total air sealing requirements validated through building diagnostic testing through the use of a blower door, which makes the installation of an air barrier (or vapor-permeable wrapping) material optional, but likely. More will be explained on this topic later.

to R-38. Vaulted ceilings with roof-ceiling combination construction should be insulated with cellulose insulation. Recessed lighting installed in enclosed soffits, and all ceiling perforations should be of the airtight or airlocked type.

Floors:

Crawl Spaces: Floors insulated to a level of R-30, or a level of insulation sufficient to fill the nominal floor joist depth (no lower than R-19). Crawl space ground cover shall be a 6-mil polyethylene vapor retarder installed over it.

Slab Floors: All slab floors on grade (or less than 24" below grade) insulated to R-10 extending a total developed depth of 24 inches.

Windows and Doors:

Window area not to exceed 12 percent of conditioned floor area.

All windows to be double-pane, low-e glass and gas-filled. All doors separating conditioned areas from unconditioned will be insulated and weather stripped. Maximum U-factors for glazed windows and opaque doors shall be U-0.32. Skylights maximum U-factor of U-0.55.

HVAC Systems:

Duct Work: All ducts in unconditioned spaces to be insulated to R-8 with all joints, seams and connections sealed with mastic.

Geothermal: All geothermal heat pumps should have a minimum 4.1 COP in the heating mode.

Air-to-Air Heat Pumps: All air-source heat pumps to have a minimum SEER of 14 in the cooling mode, and a minimum HSPF in the heating mode of at least 8.2. Touchstone Energy Home recommends a minimum 16 SEER air-source heat pump.

Ventilation:

No woodburning or gas fireplaces recommended.

All ventilation equipment to have back-draft dampers and connect directly to the exterior, not the attic.

Domestic Hot Water:

Water heaters should be set at 120 degrees, dishwashers to be ENERGY STAR-qualified, and DWH pipes insulated to a minimum level of R-3.

Lighting:

All lighting must be LED lamp fixtures.

Insulation Values

Material	Thickness (inches)	"R" Value
Clay and Concrete Masonry		
Sand and gravel concrete block	8"	1.11
Sand and gravel concrete block	12"	1.28
Face brick	4"	0.44
Poured concrete	8"	0.64
Building Materials-General		
Wood sheathing	3/4"	0.94
Fiberboard insulating	25/32"	2.06
Plywood	3/4"	0.93
Plywood	1/2"	0.62
Bevel lapped wood siding	1/2" x 8"	0.81
Bevel lapped wood siding	3/4" x 10"	1.05
Vertical tongue and groove (cedar and redwood)	3/4"	0.94
Gypsum board	1/2"	0.45
	5/8"	0.56
Interior plywood paneling	1/4"	0.31
Building paper	--	0.06
Vapor barrier	--	0.00
Asphalt roof shingles	--	0.44
Softwood (per inch)	--	1.25
Insulation Materials (*Recommended)		
*Cellulose (dry or sprayed on)	1"	3.70
*Polystyrene (molded beads)	1"	3.57
*Polystyrene (extruded smooth skin) Styrofoam	1"	5.26
*Polyisocyanurate (sheathing)	1"	7.20
*Spray polyurethane foam (closed cell)	1"	6.00
*Rockwell mineral fiber	1"	4.30
*Spray polyurethane foam (open cell)	1"	3.50
Blankets or batts (fiberglass)	5 1/2"-6"	24.00
Blankets or batts (fiberglass)	3 1/2"	14.00
Doors (Air sealing recommended for best performance)		
1 3/4" Metal Insulated Exterior Door w/ no glass	--	3.30
Patio Door	--	2.04
Patio Door (Low E Glass-gas filled)	--	3.13

Building the Home of Your Dreams

Illinois Touchstone Energy Home



Brought to you by



Association of Illinois
Electric Cooperatives

A Touchstone Energy® Member 

aiec.coop



JCE CO-OP

Your Touchstone Energy® Cooperative 